

# Staircases and dominoes: Bounding the growth rate of 1324-avoiding permutations.

Andrew Elvey Price

Joint work with David Bevan, Robert Brignall and Jay Pantone.

The University of Melbourne (and LaBRI)

Journées de combinatoire, LaBRI, 14 February 2018

# PATTERN AVOIDING PERMUTATIONS

# PATTERN AVOIDING PERMUTATIONS

- A permutation  $\pi$  (of length  $m$ ) is said to appear as a pattern in permutation  $q$  if some  $m$  of the numbers in  $q$  appear in the same relative order as the numbers in  $\pi$ .

# PATTERN AVOIDING PERMUTATIONS

- A permutation  $\pi$  (of length  $m$ ) is said to appear as a pattern in permutation  $q$  if some  $m$  of the numbers in  $q$  appear in the same relative order as the numbers in  $\pi$ .
- For example, 1324 appears as a pattern in 2753416 since the numbers 2536 are in the same relative order as 1324.

# 1324 IS A PATTERN IN 2753416

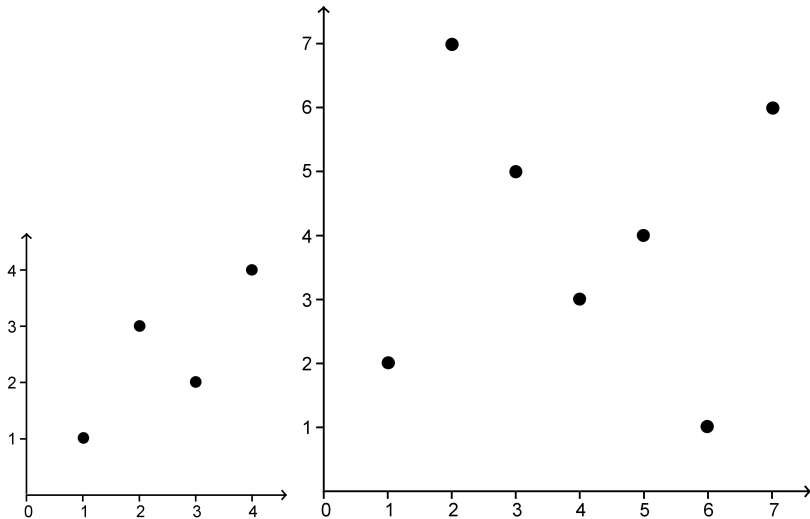

# 1324 IS A PATTERN IN 2753416

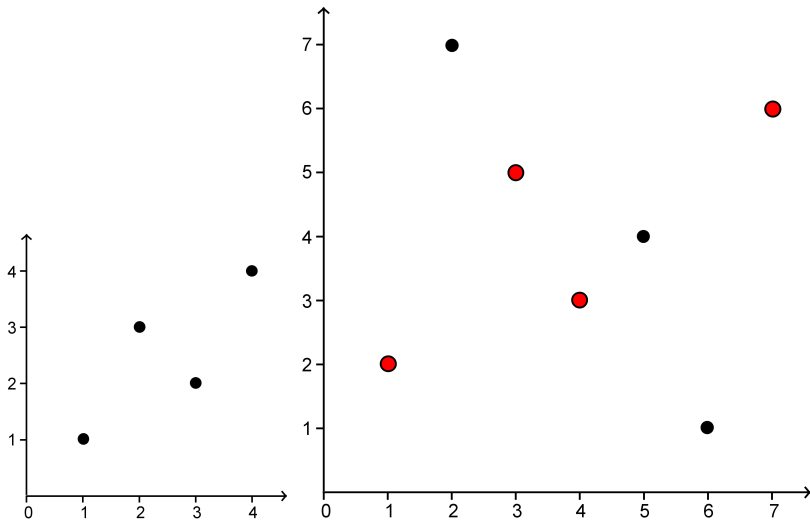

# PATTERN AVOIDING PERMUTATIONS

- A permutation  $\pi$  (of length  $m$ ) is said to appear as a pattern in permutation  $q$  if some  $m$  of the numbers in  $q$  appear in the same relative order as the numbers in  $\pi$ .
- For example, 1324 appears as a pattern in 2753416 since the numbers 2536 are in the same relative order as 1324.

# PATTERN AVOIDING PERMUTATIONS

- A permutation  $\pi$  (of length  $m$ ) is said to appear as a pattern in permutation  $q$  if some  $m$  of the numbers in  $q$  appear in the same relative order as the numbers in  $\pi$ .
- For example, 1324 appears as a pattern in 2753416 since the numbers 2536 are in the same relative order as 1324.
- Otherwise we say that  $q$  avoids the pattern  $\pi$ .



# PATTERN AVOIDING PERMUTATIONS

- A permutation  $\pi$  (of length  $m$ ) is said to appear as a pattern in permutation  $q$  if some  $m$  of the numbers in  $q$  appear in the same relative order as the numbers in  $\pi$ .
- For example, 1324 appears as a pattern in 2753416 since the numbers 2536 are in the same relative order as 1324.
- Otherwise we say that  $q$  avoids the pattern  $\pi$ .
- The set of permutations which avoid  $\pi$  is denoted  $\text{Av}(\pi)$ .

# PATTERN AVOIDING PERMUTATIONS

- A permutation  $\pi$  (of length  $m$ ) is said to appear as a pattern in permutation  $q$  if some  $m$  of the numbers in  $q$  appear in the same relative order as the numbers in  $\pi$ .
- For example, 1324 appears as a pattern in 2753416 since the numbers 2536 are in the same relative order as 1324.
- Otherwise we say that  $q$  avoids the pattern  $\pi$ .
- The set of permutations which avoid  $\pi$  is denoted  $\text{Av}(\pi)$ .
- For each  $n$ , the number of permutations of length  $n$  in  $\text{Av}(\pi)$  is denoted  $|\text{Av}_n(\pi)|$ .

# PATTERN AVOIDING PERMUTATIONS

- A permutation  $\pi$  (of length  $m$ ) is said to appear as a pattern in permutation  $q$  if some  $m$  of the numbers in  $q$  appear in the same relative order as the numbers in  $\pi$ .
- For example, 1324 appears as a pattern in 2753416 since the numbers 2536 are in the same relative order as 1324.
- Otherwise we say that  $q$  avoids the pattern  $\pi$ .
- The set of permutations which avoid  $\pi$  is denoted  $\text{Av}(\pi)$ .
- For each  $n$ , the number of permutations of length  $n$  in  $\text{Av}(\pi)$  is denoted  $|\text{Av}_n(\pi)|$ .
- Two patterns  $\pi$  and  $\tau$  are said to be "Wilf equivalent" if  $|\text{Av}_n(\pi)| = |\text{Av}_n(\tau)|$  for every  $n \in \mathbb{Z}_{\geq 0}$ .

# PATTERN AVOIDING PERMUTATIONS

- A permutation  $\pi$  (of length  $m$ ) is said to appear as a pattern in permutation  $q$  if some  $m$  of the numbers in  $q$  appear in the same relative order as the numbers in  $\pi$ .
- For example, 1324 appears as a pattern in 2753416 since the numbers 2536 are in the same relative order as 1324.
- Otherwise we say that  $q$  avoids the pattern  $\pi$ .
- The set of permutations which avoid  $\pi$  is denoted  $\text{Av}(\pi)$ .
- For each  $n$ , the number of permutations of length  $n$  in  $\text{Av}(\pi)$  is denoted  $|\text{Av}_n(\pi)|$ .
- Two patterns  $\pi$  and  $\tau$  are said to be "Wilf equivalent" if  $|\text{Av}_n(\pi)| = |\text{Av}_n(\tau)|$  for every  $n \in \mathbb{Z}_{\geq 0}$ .
- We are mostly interested in the behaviour of the sequence  $|\text{Av}_n(\pi)|$  for each permutation  $\pi$ .

# LENGTH 3 PATTERNS

# LENGTH 3 PATTERNS

- For length 3 patterns, there would seem to be two Wilf classes: 132, 213, 231 and 312 are all equivalent to each other due to reflective symmetry, and similarly 123 and 321 are equivalent.

# LENGTH 3 PATTERNS

- For length 3 patterns, there would seem to be two Wilf classes: 132, 213, 231 and 312 are all equivalent to each other due to reflective symmetry, and similarly 123 and 321 are equivalent.
- Remarkably, these are all Wilf equivalent as

$$|\text{Av}_n(123)| = |\text{Av}_n(132)| = \frac{1}{n+1} \binom{2n}{n},$$

the  $n$ th Catalan number.

# LENGTH 4 PATTERNS



# LENGTH 4 PATTERNS

- For length 4 patterns, there are only three Wilf classes, which have representatives 1342, 1234 and 1324.

## LENGTH 4 PATTERNS

- For length 4 patterns, there are only three Wilf classes, which have representatives 1342, 1234 and 1324.
- The sequence  $|Av_n(1342)|$  is given by the coefficients of the algebraic generating function

$$\frac{32x}{1 + 12x - 8x^2 - (1 - 8x)^{3/2}}.$$

# LENGTH 4 PATTERNS

- For length 4 patterns, there are only three Wilf classes, which have representatives 1342, 1234 and 1324.
- The sequence  $|Av_n(1342)|$  is given by the coefficients of the algebraic generating function

$$\frac{32x}{1 + 12x - 8x^2 - (1 - 8x)^{3/2}}.$$

- The sequence  $|Av_n(1234)|$  is not algebraic, but it is D-finite.

# LENGTH 4 PATTERNS

- For length 4 patterns, there are only three Wilf classes, which have representatives 1342, 1234 and 1324.
- The sequence  $|Av_n(1342)|$  is given by the coefficients of the algebraic generating function

$$\frac{32x}{1 + 12x - 8x^2 - (1 - 8x)^{3/2}}.$$

- The sequence  $|Av_n(1234)|$  is not algebraic, but it is D-finite.
- The sequence  $|Av_n(1324)|$  is a mystery.

# LENGTH 4 PATTERNS

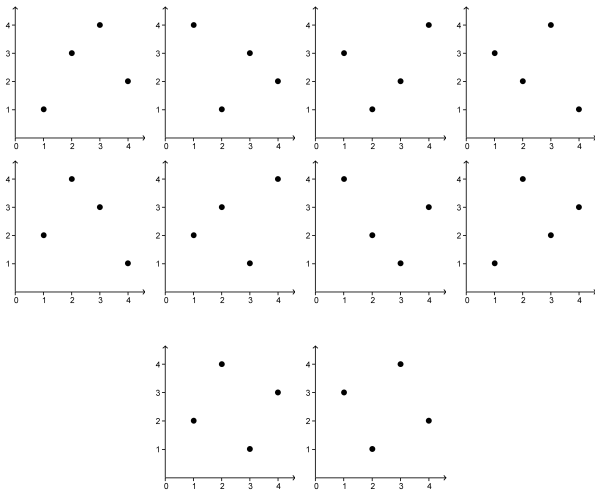

# LENGTH 4 PATTERNS

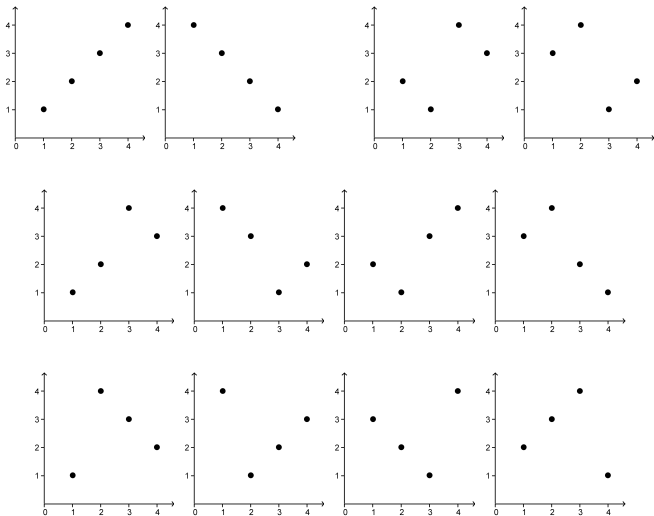

# LENGTH 4 PATTERNS

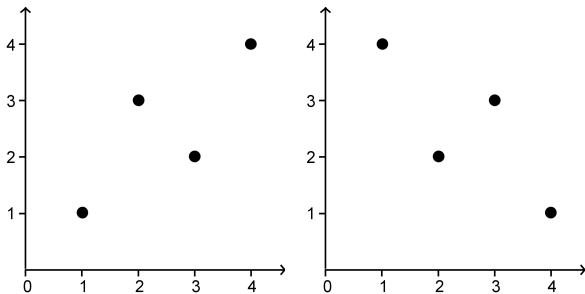

# MARCOS-TARDOS THEOREM



# MARCOS-TARDOS THEOREM

For any permutation  $\pi$ , the limit

$$\text{gr}(\text{Av}(\pi)) = \lim_{n \rightarrow \infty} \sqrt[n]{|\text{Av}_n(\pi)|}$$

exists, and is finite.

# MARCOS-TARDOS THEOREM

For any permutation  $\pi$ , the limit

$$\text{gr}(\text{Av}(\pi)) = \lim_{n \rightarrow \infty} \sqrt[n]{|\text{Av}_n(\pi)|}$$

exists, and is finite.

This is called the Stanley-Wilf limit of  $\pi$ .

# KNOWN STANLEY-WILF LIMITS

# KNOWN STANLEY-WILF LIMITS

- We already saw that for patterns  $\pi$  of length 3, the sequence  $|\text{Av}_n(\pi)|$  is given by the Catalan numbers, so  $\text{gr}(\text{Av}(\pi)) = 4$ .

# KNOWN STANLEY-WILF LIMITS

- We already saw that for patterns  $\pi$  of length 3, the sequence  $|\text{Av}_n(\pi)|$  is given by the Catalan numbers, so  $\text{gr}(\text{Av}(\pi)) = 4$ .
- $\text{gr}(\text{Av}(1342)) = 8$ .

# KNOWN STANLEY-WILF LIMITS

- We already saw that for patterns  $\pi$  of length 3, the sequence  $|\text{Av}_n(\pi)|$  is given by the Catalan numbers, so  $\text{gr}(\text{Av}(\pi)) = 4$ .
- $\text{gr}(\text{Av}(1342)) = 8$ .
- $\text{grAv}(1234) = 9$ .

# KNOWN STANLEY-WILF LIMITS

- We already saw that for patterns  $\pi$  of length 3, the sequence  $|\text{Av}_n(\pi)|$  is given by the Catalan numbers, so  $\text{gr}(\text{Av}(\pi)) = 4$ .
- $\text{gr}(\text{Av}(1342)) = 8$ .
- $\text{grAv}(1234) = 9$ .
- $\text{gr}(\text{Av}(1234 \dots n)) = (n - 1)^2$ .

# KNOWN STANLEY-WILF LIMITS

- We already saw that for patterns  $\pi$  of length 3, the sequence  $|\text{Av}_n(\pi)|$  is given by the Catalan numbers, so  $\text{gr}(\text{Av}(\pi)) = 4$ .
- $\text{gr}(\text{Av}(1342)) = 8$ .
- $\text{grAv}(1234) = 9$ .
- $\text{gr}(\text{Av}(1234 \dots n)) = (n - 1)^2$ .
- Very few other Stanley-Wilf limits are known.



# SOME HISTORY OF STANLEY-WILF LIMITS

# SOME HISTORY OF STANLEY-WILF LIMITS

- Arratia (1999): Conjectures that any Stanley-Wilf limit  $\text{gr}(\text{Av}(\pi)) \leq (|\pi| - 1)^2$ .

# SOME HISTORY OF STANLEY-WILF LIMITS

- Arratia (1999): Conjectures that any Stanley-Wilf limit  $\text{gr}(\text{Av}(\pi)) \leq (|\pi| - 1)^2$ . In other words, he conjectured that increasing permutations are the easiest permutations to avoid.

# SOME HISTORY OF STANLEY-WILF LIMITS

- Arratia (1999): Conjectures that any Stanley-Wilf limit  $\text{gr}(\text{Av}(\pi)) \leq (|\pi| - 1)^2$ . In other words, he conjectured that increasing permutations are the easiest permutations to avoid.
- Marcos, Tardos (2004): The Stanley-Wilf limit  $\text{gr}(\text{Av}(\pi))$  exists for any permutation  $\pi$ .

# SOME HISTORY OF STANLEY-WILF LIMITS

- Arratia (1999): Conjectures that any Stanley-Wilf limit  $\text{gr}(\text{Av}(\pi)) \leq (|\pi| - 1)^2$ . In other words, he conjectured that increasing permutations are the easiest permutations to avoid.
- Marcos, Tardos (2004): The Stanley-Wilf limit  $\text{gr}(\text{Av}(\pi))$  exists for any permutation  $\pi$ .
- Albert, Elder, Rechnitzer, Wescott and Zabroski (2006):  $\text{gr}(\text{Av}(1324)) > 9.47$ , refuting Arratia's conjecture.

# SOME HISTORY OF STANLEY-WILF LIMITS

- Arratia (1999): Conjectures that any Stanley-Wilf limit  $\text{gr}(\text{Av}(\pi)) \leq (|\pi| - 1)^2$ . In other words, he conjectured that increasing permutations are the easiest permutations to avoid.
- Marcos, Tardos (2004): The Stanley-Wilf limit  $\text{gr}(\text{Av}(\pi))$  exists for any permutation  $\pi$ .
- Albert, Elder, Rechnitzer, Wescott and Zabroski (2006):  $\text{gr}(\text{Av}(1324)) > 9.47$ , refuting Arratia's conjecture.
- Fox (2013):  
For  $\alpha < 1/4$ , almost all permutations  $\pi$  satisfy

$$\text{gr}(\text{Av}(\pi)) > 2^{|\pi|^\alpha}.$$

# EXACT ENUMERATION OF 1324-AVOIDERS

# EXACT ENUMERATION OF 1324-AVOIDERS

- This is difficult.



# EXACT ENUMERATION OF 1324-AVOIDERS

- This is difficult. According to Doron Zeilberger: “*not even god knows  $|Av_{1000}(1324)|$* ”.

# EXACT ENUMERATION OF 1324-AVOIDERS

- This is difficult. According to Doron Zeilberger: “*not even god knows  $|Av_{1000}(1324)|$* ”.
- So far humans (Andrew Conway and Paul Zinn-Justin) have computed up to  $|Av_{50}(1324)|$ .

# EXACT ENUMERATION OF 1324-AVOIDERS

- This is difficult. According to Doron Zeilberger: “*not even god knows  $|Av_{1000}(1324)|$* ”.
- So far humans (Andrew Conway and Paul Zinn-Justin) have computed up to  $|Av_{50}(1324)|$ .
- Tony Guttmann’s analysis of this series suggests that

$$|Av_n(1324)| \sim B \cdot \mu^n \cdot \mu_1^{n^\sigma} \cdot n^\theta,$$

where  $\mu = \text{gr}(Av(1324)) \approx 11.6$ ,  $\sigma = 1/2$ ,  $\mu_1 \approx 0.04$  and  $B$  is some constant.

# EXACT ENUMERATION OF 1324-AVOIDERS

- This is difficult. According to Doron Zeilberger: “*not even god knows*  $|Av_{1000}(1324)|$ ”.
- So far humans (Andrew Conway and Paul Zinn-Justin) have computed up to  $|Av_{50}(1324)|$ .
- Tony Guttmann’s analysis of this series suggests that

$$|Av_n(1324)| \sim B \cdot \mu^n \cdot \mu_1^{n^\sigma} \cdot n^\theta,$$

where  $\mu = \text{gr}(Av(1324)) \approx 11.6$ ,  $\sigma = 1/2$ ,  $\mu_1 \approx 0.04$  and  $B$  is some constant.

- The presence of the  $\mu_1^{n^\sigma}$  term suggests that the sequence  $Av_n(1324)$  is not D-finite.

# BOUNDS ON $\text{GR}(\text{AV}(1324))$

# BOUNDS ON $\text{GR}(\text{Av}(1324))$

2004: Bóna

$$\text{gr}(\text{Av}(1324)) \leq 288$$

# BOUNDS ON $\text{GR}(\text{Av}(1324))$

2004: Bóna

$$\text{gr}(\text{Av}(1324)) \leq 288$$

2005: Bóna

$$9 \leq \text{gr}(\text{Av}(1324))$$

# BOUNDS ON $\text{GR}(\text{Av}(1324))$

2004: Bóna	$\text{gr}(\text{Av}(1324)) \leq 288$
2005: Bóna	$9 \leq \text{gr}(\text{Av}(1324))$
2006: Albert et al	$9.47 \leq \text{gr}(\text{Av}(1324))$



# BOUNDS ON $\text{GR}(\text{Av}(1324))$

2004: Bóna	$\text{gr}(\text{Av}(1324)) \leq 288$
2005: Bóna	$9 \leq \text{gr}(\text{Av}(1324))$
2006: Albert et al	$9.47 \leq \text{gr}(\text{Av}(1324))$
2012: Claesson et al	$\text{gr}(\text{Av}(1324)) \leq 16$

# BOUNDS ON $\text{GR}(\text{Av}(1324))$

2004: Bóna	$\text{gr}(\text{Av}(1324)) \leq 288$
2005: Bóna	$9 \leq \text{gr}(\text{Av}(1324))$
2006: Albert et al	$9.47 \leq \text{gr}(\text{Av}(1324))$
2012: Claesson et al	$\text{gr}(\text{Av}(1324)) \leq 16$
2014: Bóna	$\text{gr}(\text{Av}(1324)) \leq 13.93$

# BOUNDS ON $\text{GR}(\text{Av}(1324))$

2004: Bóna	$\text{gr}(\text{Av}(1324)) \leq 288$
2005: Bóna	$9 \leq \text{gr}(\text{Av}(1324))$
2006: Albert et al	$9.47 \leq \text{gr}(\text{Av}(1324))$
2012: Claesson et al	$\text{gr}(\text{Av}(1324)) \leq 16$
2014: Bóna	$\text{gr}(\text{Av}(1324)) \leq 13.93$
2015: Bóna	$\text{gr}(\text{Av}(1324)) \leq 13.74$

# BOUNDS ON $\text{gr}(\text{Av}(1324))$

2004: Bóna	$\text{gr}(\text{Av}(1324)) \leq 288$
2005: Bóna	$9 \leq \text{gr}(\text{Av}(1324))$
2006: Albert et al	$9.47 \leq \text{gr}(\text{Av}(1324))$
2012: Claesson et al	$\text{gr}(\text{Av}(1324)) \leq 16$
2014: Bóna	$\text{gr}(\text{Av}(1324)) \leq 13.93$
2015: Bóna	$\text{gr}(\text{Av}(1324)) \leq 13.74$
2015: Bevan	$9.81 \leq \text{gr}(\text{Av}(1324))$

# BOUNDS ON $\text{gr}(\text{Av}(1324))$

2004: Bóna	$\text{gr}(\text{Av}(1324)) \leq 288$
2005: Bóna	$9 \leq \text{gr}(\text{Av}(1324))$
2006: Albert et al	$9.47 \leq \text{gr}(\text{Av}(1324))$
2012: Claesson et al	$\text{gr}(\text{Av}(1324)) \leq 16$
2014: Bóna	$\text{gr}(\text{Av}(1324)) \leq 13.93$
2015: Bóna	$\text{gr}(\text{Av}(1324)) \leq 13.74$
2015: Bevan	$9.81 \leq \text{gr}(\text{Av}(1324))$

Theorem (Bevan, Brignall, E., Pantone)

$$10.27 \leq \text{gr}(\text{Av}(1324)) \leq 13.5.$$

# STAIRCASING A 1324-AVOIDER

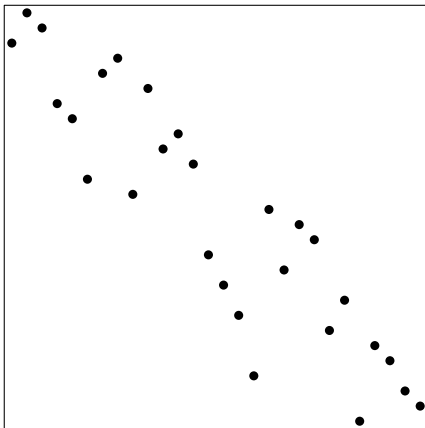

# STAIRCASING A 1324-AVOIDER

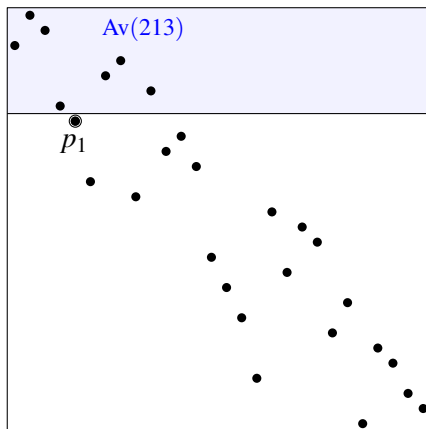

- $p_1$  uppermost 1 in a 213.

# STAIRCASING A 1324-AVOIDER

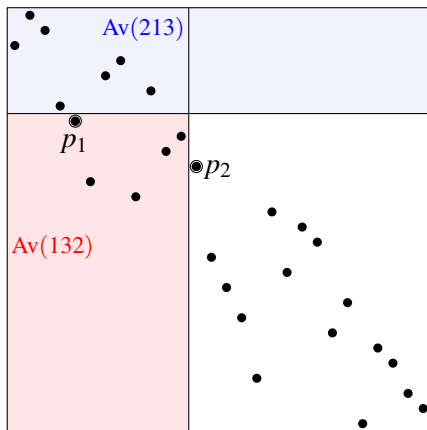

- $p_1$  uppermost 1 in a 213.
- $p_2$  leftmost 2 in a 132 consisting of points below  $p_1$  divider.



# STAIRCASING A 1324-AVOIDER

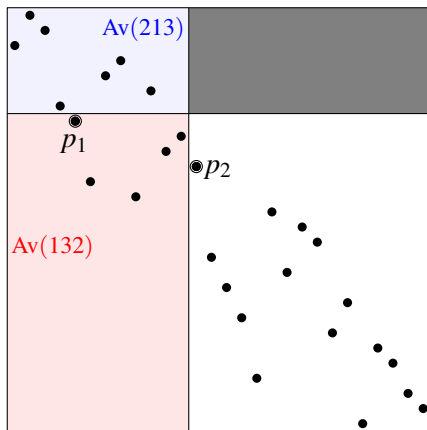

- $p_2$  leftmost 2 in a 132 consisting of points below  $p_1$  divider.
- No points above  $p_1$  and to the right of  $p_2$ .

# STAIRCASING A 1324-AVOIDER

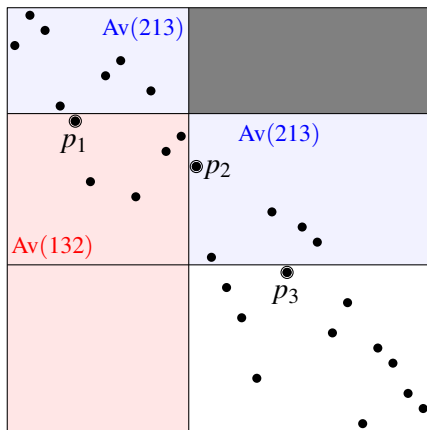

- $p_2$  leftmost 2 in a 132 consisting of points below  $p_1$  divider.
- $p_3$  uppermost 1 in a 213 consisting of points to right of  $p_2$  divider.

# STAIRCASING A 1324-AVOIDER

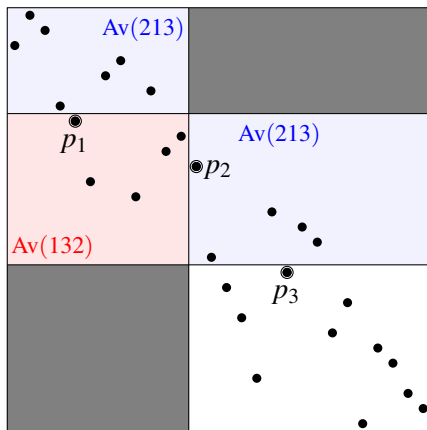

- $p_3$  uppermost 1 in a 213 consisting of points to right of  $p_2$  divider.
- No points to the left of  $p_2$  and below  $p_3$ .

# STAIRCASING A 1324-AVOIDER

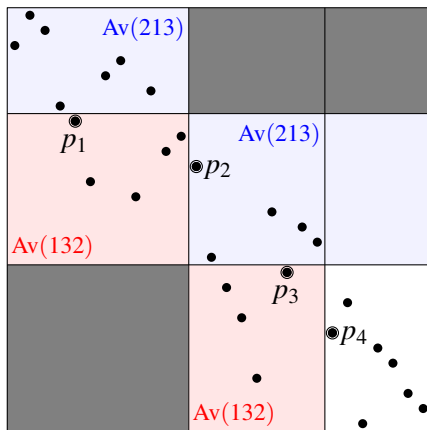

- $p_3$  uppermost 1 in a 213 consisting of points to right of  $p_2$  divider.
- $p_4$  leftmost 2 in a 132 consisting of points below  $p_3$  divider.

# STAIRCASING A 1324-AVOIDER

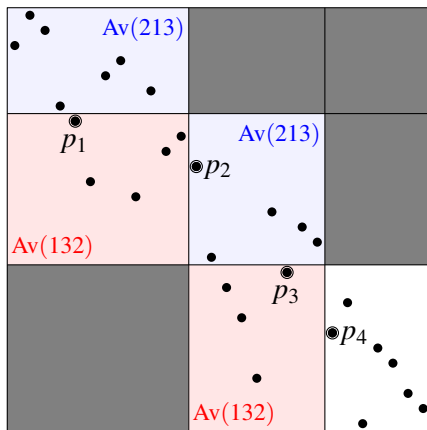

- $p_4$  leftmost 2 in a 132 consisting of points below  $p_3$  divider.
- No points above  $p_3$  and to the right of  $p_4$ .

# STAIRCASING A 1324-AVOIDER

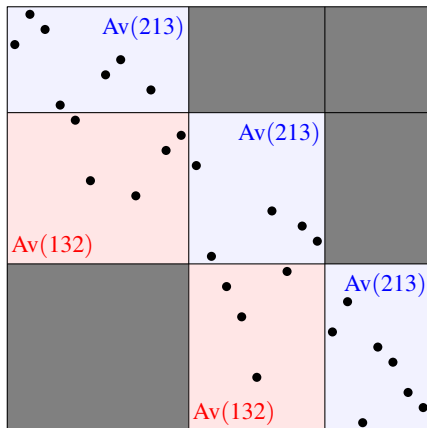

- The final cell avoids 213.

# A LARGE STAIRCASED 1324-AVOIDER

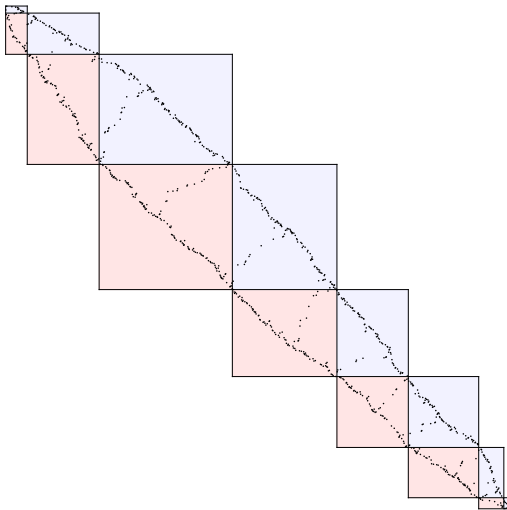

Data provided by Einar Steingrímsson.

# UPPER BOUND ON $\text{GR}(\text{Av}(1324))$

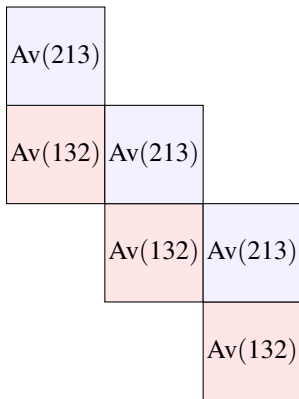



# UPPER BOUND ON $\text{GR}(\text{Av}(1324))$

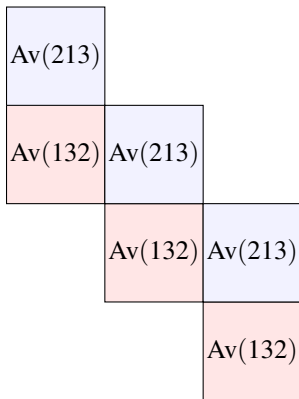

This already gives us an upper bound:  $|\text{Av}_n(1324)|$  is less than the number of staircases with  $n$  points, which grows like  $16^n$ .

# DOMINOES

A domino is a *gridded permutation* in

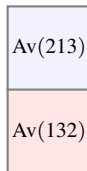

that avoids 1324.

# DOMINOES

A domino is a *gridded permutation* in

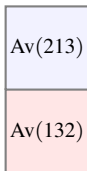

that avoids 1324.

That is, a 1324-avoiding staircase with two cells.

# DOMINOES

A domino is a *gridded permutation* in

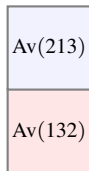

that avoids 1324.

That is, a 1324-avoiding staircase with two cells.

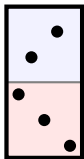

$\neq$

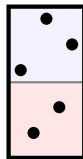
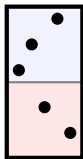

$\neq$

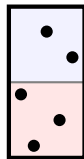

# DOMINOES

A domino is a *gridded permutation* in

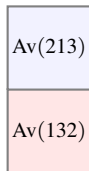

that avoids 1324.

That is, a 1324-avoiding staircase with two cells.

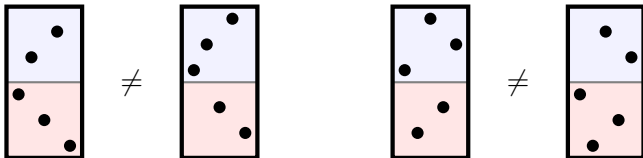

Claim: The number of  $n$ -point dominoes is:

# DOMINOES

A domino is a *gridded permutation* in

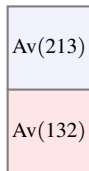

that avoids 1324.

That is, a 1324-avoiding staircase with two cells.

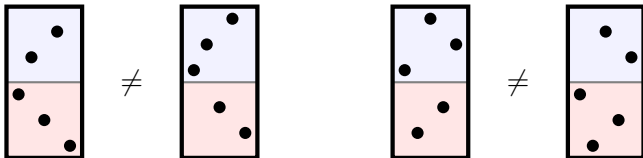

Claim: The number of  $n$ -point dominoes is: 
$$\frac{2(3n + 3)!}{(n + 2)!(2n + 3)!}.$$

# DOMINOES

The number of (1324-avoiding) dominoes with  $n$  points is

$$\frac{2(3n + 3)!}{(n + 2)!(2n + 3)!}$$

# DOMINOES

The number of (1324-avoiding) dominoes with  $n$  points is

$$\frac{2(3n + 3)!}{(n + 2)!(2n + 3)!}$$

Enrica Duchi talked about these numbers yesterday!



# DOMINOES

The number of (1324-avoiding) dominoes with  $n$  points is

$$\frac{2(3n + 3)!}{(n + 2)!(2n + 3)!}$$

Enrica Duchi talked about these numbers yesterday! This is also the number of...

# DOMINOES

The number of (1324-avoiding) dominoes with  $n$  points is

$$\frac{2(3n + 3)!}{(n + 2)!(2n + 3)!}$$

Enrica Duchi talked about these numbers yesterday! This is also the number of...

# DOMINOES

The number of (1324-avoiding) dominoes with  $n$  points is

$$\frac{2(3n + 3)!}{(n + 2)!(2n + 3)!}$$

Enrica Duchi talked about these numbers yesterday! This is also the number of...

- Fighting fish with semi-perimeter  $n + 2$ .

# DOMINOES

The number of (1324-avoiding) dominoes with  $n$  points is

$$\frac{2(3n + 3)!}{(n + 2)!(2n + 3)!}$$

Enrica Duchi talked about these numbers yesterday! This is also the number of...

- Fighting fish with semi-perimeter  $n + 2$ .
- West two-stack sortable permutations of length  $n + 1$ .

# DOMINOES

The number of (1324-avoiding) dominoes with  $n$  points is

$$\frac{2(3n + 3)!}{(n + 2)!(2n + 3)!}$$

Enrica Duchi talked about these numbers yesterday! This is also the number of...

- Fighting fish with semi-perimeter  $n + 2$ .
- West two-stack sortable permutations of length  $n + 1$ .
- Left ternary trees with  $n + 1$  vertices.

# DOMINOES

The number of (1324-avoiding) dominoes with  $n$  points is

$$\frac{2(3n + 3)!}{(n + 2)!(2n + 3)!}$$

Enrica Duchi talked about these numbers yesterday! This is also the number of...

- Fighting fish with semi-perimeter  $n + 2$ .
- West two-stack sortable permutations of length  $n + 1$ .
- Left ternary trees with  $n + 1$  vertices.
- Rooted non-separable planar maps with  $n + 1$  edges.

# BIJECTING 213/132-AVOIDERS TO ARCH SYSTEMS

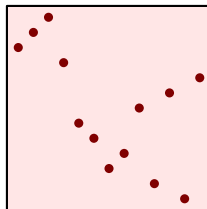
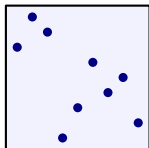

A 213-avoider and a 132-avoider

# BIJECTING 213/132-AVOIDERS TO ARCH SYSTEMS

- vertically project the points in the permutation.

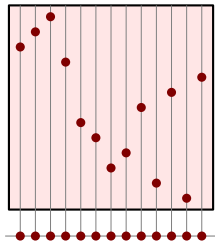
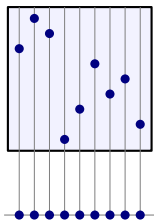

A 213-avoider and a 132-avoider with their arch systems



# BIJECTING 213/132-AVOIDERS TO ARCH SYSTEMS

- vertically project the points in the permutation.
- draw an arch between two points when the right point in the permutation is one higher than the left point.

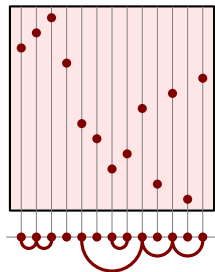
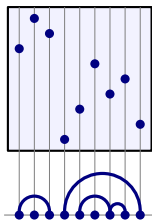

A 213-avoider and a 132-avoider with their arch systems

# BIJECTING 213/132-AVOIDERS TO ARCH SYSTEMS

These arch systems satisfy the following properties:

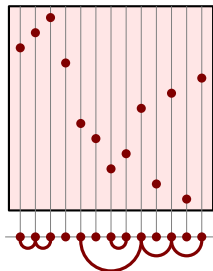
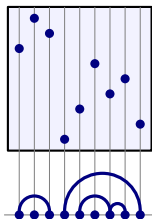

# BIJECTING 213/132-AVOIDERS TO ARCH SYSTEMS

These arch systems satisfy the following properties:

- Each point is at the left end of at most one arch.

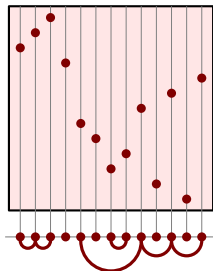
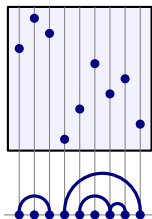

# BIJECTING 213/132-AVOIDERS TO ARCH SYSTEMS

These arch systems satisfy the following properties:

- Each point is at the left end of at most one arch.
- Each point is at the right end of at most one arch.

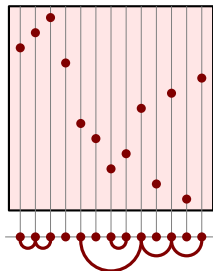
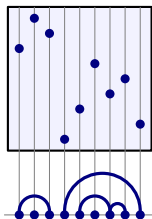

# BIJECTING 213/132-AVOIDERS TO ARCH SYSTEMS

These arch systems satisfy the following properties:

- Each point is at the left end of at most one arch.
- Each point is at the right end of at most one arch.
- No two arches cross.

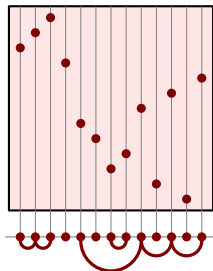
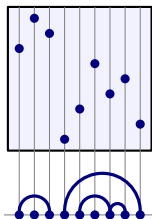

# BIJECTING DOMINOES TO ARCH CONFIGURATIONS.

# BIJECTING DOMINOES TO ARCH CONFIGURATIONS.

- This naturally extends to a bijection between dominoes and arch configurations.

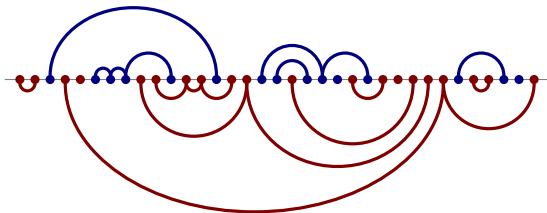

# BIJECTING DOMINOES TO ARCH CONFIGURATIONS.

- This naturally extends to a bijection between dominoes and arch configurations.
- The 1324-avoiding condition corresponds to forbidding the pattern  in the arch configuration.

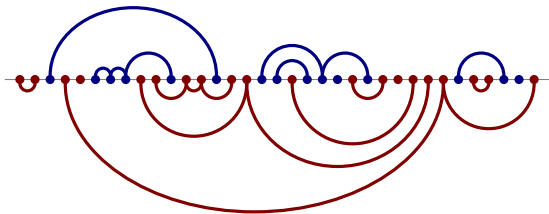



# ENUMERATING ARCH SYSTEMS

# ENUMERATING ARCH SYSTEMS

We have reduced enumerating dominoes (with  $n$  points) to enumerating arch systems (with  $n$  points) in which

# ENUMERATING ARCH SYSTEMS

We have reduced enumerating dominoes (with  $n$  points) to enumerating arch systems (with  $n$  points) in which

- no two arches of the same colour cross.

# ENUMERATING ARCH SYSTEMS

We have reduced enumerating dominoes (with  $n$  points) to enumerating arch systems (with  $n$  points) in which

- no two arches of the same colour cross.
- no two arches have the same right endpoint or the same left endpoint.

# ENUMERATING ARCH SYSTEMS

We have reduced enumerating dominoes (with  $n$  points) to enumerating arch systems (with  $n$  points) in which

- no two arches of the same colour cross.
- no two arches have the same right endpoint or the same left endpoint.
- The pattern  does not occur anywhere.

# ENUMERATING ARCH SYSTEMS

We have reduced enumerating dominoes (with  $n$  points) to enumerating arch systems (with  $n$  points) in which

- no two arches of the same colour cross.
- no two arches have the same right endpoint or the same left endpoint.
- The pattern  does not occur anywhere.

It helps to count prefixes of arch systems, which may have open red arches.

# ENUMERATING ARCH SYSTEMS

We have reduced enumerating dominoes (with  $n$  points) to enumerating arch systems (with  $n$  points) in which

- no two arches of the same colour cross.
- no two arches have the same right endpoint or the same left endpoint.
- The pattern  does not occur anywhere.

It helps to count prefixes of arch systems, which may have open red arches.

We use a generating function  $A(t, z)$  which counts these prefixes by points ( $t$ ) and number of open arches ( $z$ ).

# ENUMERATING ARCH SYSTEMS

We have reduced enumerating dominoes (with  $n$  points) to enumerating arch systems (with  $n$  points) in which

- no two arches of the same colour cross.
- no two arches have the same right endpoint or the same left endpoint.
- The pattern  does not occur anywhere.

It helps to count prefixes of arch systems, which may have open red arches.

We use a generating function  $A(t, z)$  which counts these prefixes by points ( $t$ ) and number of open arches ( $z$ ).

Then the number of dominoes with  $n$  points is  $[t^n]A(t, 0)$ .



# DECOMPOSITION OF ARCH SYSTEM PREFIXES

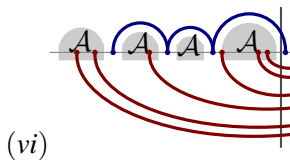
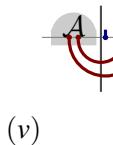
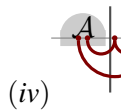
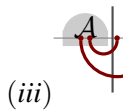
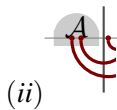
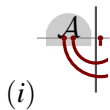

# DECOMPOSITION OF ARCH SYSTEM PREFIXES

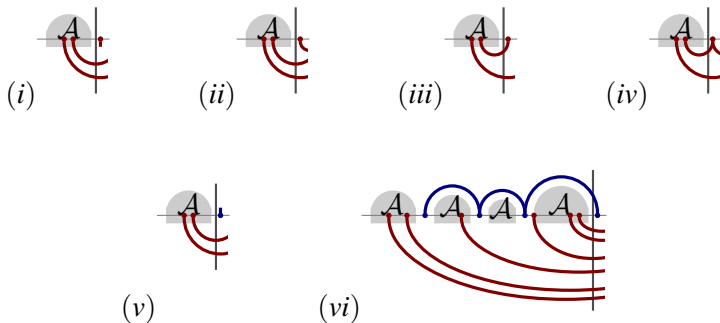

This decomposition leads to the equation:

$$A(z) = tA(z) + tzA(z) + t(1+z)\frac{A(z) - A(0)}{z} + \frac{1}{1-tA(z)}.$$

# ENUMERATING ARCH SYSTEMS

- The generating function  $A(t, z)$  is characterised by the equation

$$A(z) = tA(z) + tzA(z) + t(1+z)\frac{A(z) - A(0)}{z} + \frac{1}{1 - tA(z)}.$$

# ENUMERATING ARCH SYSTEMS

- The generating function  $A(t, z)$  is characterised by the equation

$$A(z) = tA(z) + tzA(z) + t(1+z)\frac{A(z) - A(0)}{z} + \frac{1}{1 - tA(z)}.$$

- This can be solved by Bouquet-Melou and Jehanne's generalisation of the Kernel method.

# ENUMERATING ARCH SYSTEMS

- The generating function  $A(t, z)$  is characterised by the equation

$$A(z) = tA(z) + tzA(z) + t(1+z)\frac{A(z) - A(0)}{z} + \frac{1}{1 - tA(z)}.$$

- This can be solved by Bouquet-Melou and Jehanne's generalisation of the Kernel method. See: "*Polynomial equations with one catalytic variable, algebraic series and map enumeration*" (2006)

# ENUMERATING ARCH SYSTEMS

- The generating function  $A(t, z)$  is characterised by the equation

$$A(z) = tA(z) + tzA(z) + t(1+z)\frac{A(z) - A(0)}{z} + \frac{1}{1 - tA(z)}.$$

- This can be solved by Bouquet-Melou and Jehanne's generalisation of the Kernel method. See: "*Polynomial equations with one catalytic variable, algebraic series and map enumeration*" (2006)
- Now we have enumerated dominos!

# ENUMERATING ARCH SYSTEMS

- The generating function  $A(t, z)$  is characterised by the equation

$$A(z) = tA(z) + tzA(z) + t(1+z)\frac{A(z) - A(0)}{z} + \frac{1}{1 - tA(z)}.$$

- This can be solved by Bouquet-Melou and Jehanne's generalisation of the Kernel method. See: "*Polynomial equations with one catalytic variable, algebraic series and map enumeration*" (2006)
- Now we have enumerated dominos!
- We can use these dominoes to get better upper and lower bounds for  $\text{gr}(\text{Av}(1324))$

# UPPER BOUND ON $\text{GR}(\text{AV}(1324))$



# UPPER BOUND ON $\text{GR}(\text{Av}(1324))$

- Start with a 1324-avoiding permutation, and staircase it.

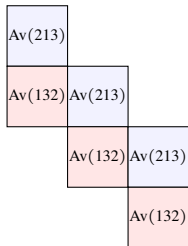

# UPPER BOUND ON $\text{GR}(\text{Av}(1324))$

- Start with a 1324-avoiding permutation, and staircase it it.
- Use  $\Phi$  to construct a large domino as shown.

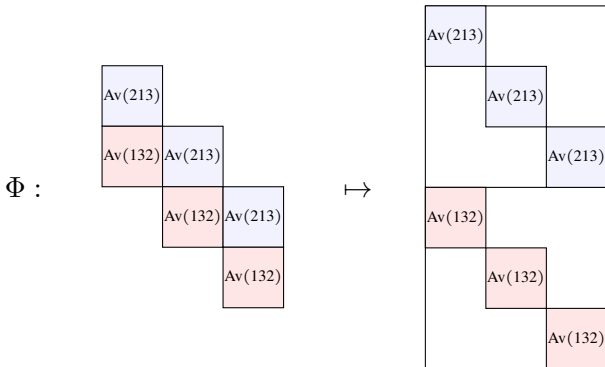

# UPPER BOUND ON $\text{GR}(\text{Av}(1324))$

- Start with a 1324-avoiding permutation, and staircase it it.
- Use  $\Phi$  to construct a large domino as shown.
- $\Phi$  is not injective.

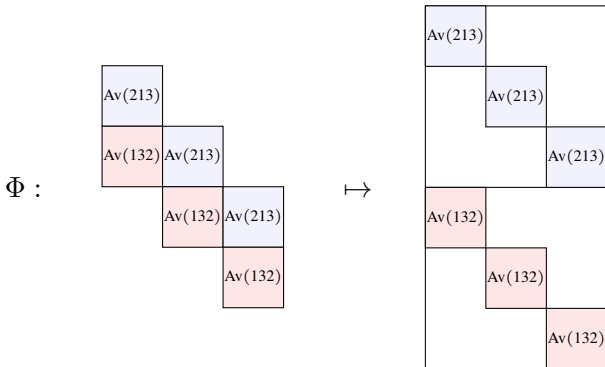



# UPPER BOUND ON $\text{GR}(\text{AV}(1324))$

$$\Psi : \text{Av}_n(1324) \rightarrow (\bullet, \bullet)^n \times D_n$$

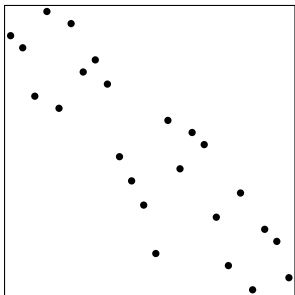

$\mapsto$

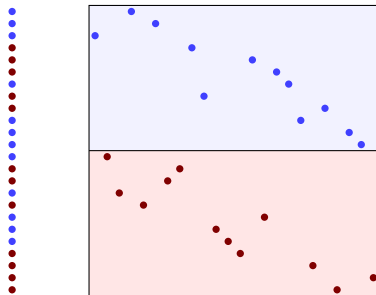

# UPPER BOUND ON $\text{GR}(\text{Av}(1324))$

$$\Psi : \text{Av}_n(1324) \rightarrow (\bullet, \bullet)^n \times D_n$$

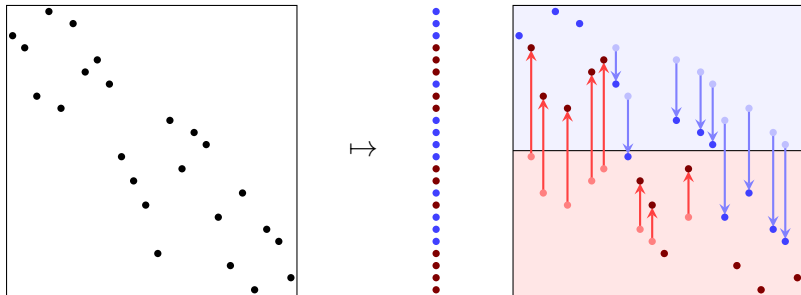

- The vertical interleaving can be recovered from the  $\bullet \bullet$  sequence.

# UPPER BOUND ON $\text{GR}(\text{Av}(1324))$

$$\Psi : \text{Av}_n(1324) \rightarrow (\bullet, \bullet)^n \times D_n$$

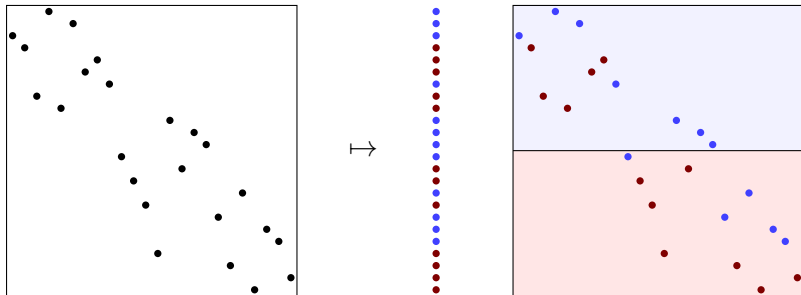

- The vertical interleaving can be recovered from the  $\bullet \bullet$  sequence.
- $\Psi$  is injective.  $\text{gr}(\text{Av}(1324)) \leq 2 \times 27/4 = 13.5$

# LOWER BOUND



# LOWER BOUND

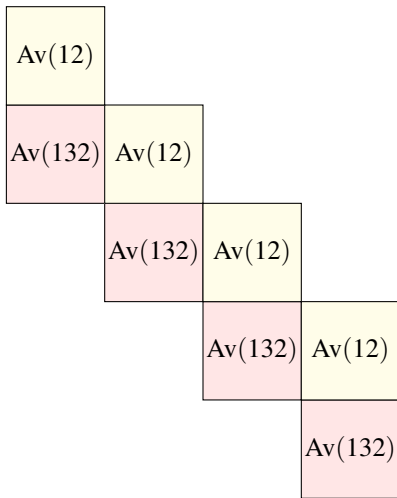

This staircase always defines a 1324-avoider.

# LOWER BOUND

- To get a lower bound, we can count staircases whose cells alternate 132-avoiding and 12-avoiding.

# LOWER BOUND

- To get a lower bound, we can count staircases whose cells alternate 132-avoiding and 12-avoiding.
- We can enumerate these exactly: their exponential growth rate is 9.

# BETTER LOWER BOUND

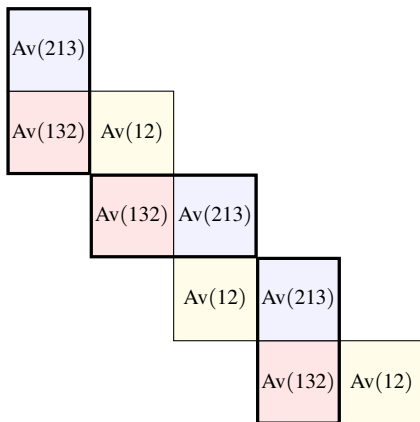

# BETTER LOWER BOUND

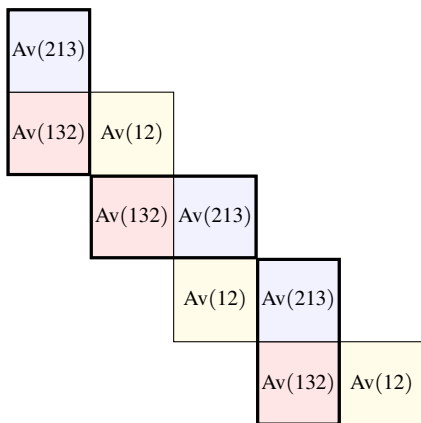

- Count 1324-avoiding staircases in which every third cell is 12-avoiding.

# BETTER LOWER BOUND

# BETTER LOWER BOUND

- Since we have enumerated dominoes, we can enumerate these exactly.

## BETTER LOWER BOUND

- Since we have enumerated dominoes, we can enumerate these exactly. Their growth rate is  $\approx 9.895$ .



## BETTER LOWER BOUND

- Since we have enumerated dominoes, we can enumerate these exactly. Their growth rate is  $\approx 9.895$ .
- There is a simple way to improve on this: After constructing a 1324 avoiding permutation in the way just described, each element in an  $Av(12)$  section can be replaced with any 213-avoider.

## BETTER LOWER BOUND

- Since we have enumerated dominoes, we can enumerate these exactly. Their growth rate is  $\approx 9.895$ .
- There is a simple way to improve on this: After constructing a 1324 avoiding permutation in the way just described, each element in an  $Av(12)$  section can be replaced with any 213-avoider.
- To avoid over counting, we only use 213-avoiders which start with 1.

## BETTER LOWER BOUND

- Since we have enumerated dominoes, we can enumerate these exactly. Their growth rate is  $\approx 9.895$ .
- There is a simple way to improve on this: After constructing a 1324 avoiding permutation in the way just described, each element in an  $\text{Av}(12)$  section can be replaced with any 213-avoider.
- To avoid over counting, we only use 213-avoiders which start with 1.
- Taking limits carefully, this gives a lower bound for  $\text{gr}(\text{Av}(1324))$  of 10.125.

# BETTER BOUNDS

# BETTER BOUNDS

- In current work with David Bevan, Robert Brignall and Jay Pantone, we have refined this to show that  $\text{gr}(\text{Av}(1324)) \geq 10.271$ .

# BETTER BOUNDS

- In current work with David Bevan, Robert Brignall and Jay Pantone, we have refined this to show that  $\text{gr}(\text{Av}(1324)) \geq 10.271$ .
- We have been unable to refine the upper bound further than  $\text{gr}(\text{Av}(1324)) \leq 13.5$ .

# BETTER BOUNDS

- In current work with David Bevan, Robert Brignall and Jay Pantone, we have refined this to show that  $\text{gr}(\text{Av}(1324)) \geq 10.271$ .
- We have been unable to refine the upper bound further than  $\text{gr}(\text{Av}(1324)) \leq 13.5$ .
- There is still a long way to go to get near Guttman's estimate of 11.6.

# QUESTIONS FOR THE AUDIENCE



# QUESTIONS FOR THE AUDIENCE

Can anyone...

# QUESTIONS FOR THE AUDIENCE

Can anyone...

- Find a bijective proof of the number of dominoes?

# QUESTIONS FOR THE AUDIENCE

Can anyone...

- Find a bijective proof of the number of dominoes?
- Enumerate the number of 1324-avoiding staircases with 3 cells?

# QUESTIONS FOR THE AUDIENCE

Can anyone...

- Find a bijective proof of the number of dominoes?
- Enumerate the number of 1324-avoiding staircases with 3 cells?
- Improve the upper bound?

# QUESTIONS FOR THE AUDIENCE

Can anyone...

- Find a bijective proof of the number of dominoes?
- Enumerate the number of 1324-avoiding staircases with 3 cells?
- Improve the upper bound?
- Compute  $|Av_{1000}(1324)|$ ??

THANK YOU